

Комплект заданий для учащихся 7-8 классов

Part 1. Listening

Time: 15 minutes

Listen to the short recordings. For each question (1-7), choose the correct answer. You will hear the recordings twice. Transfer your answers to your answer sheet.

1. What did the girl buy on her shopping trip?

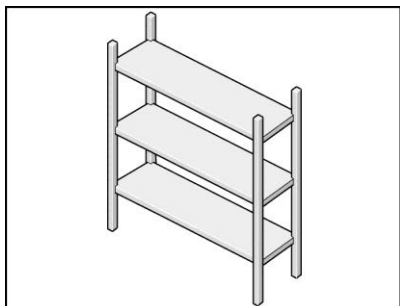

A

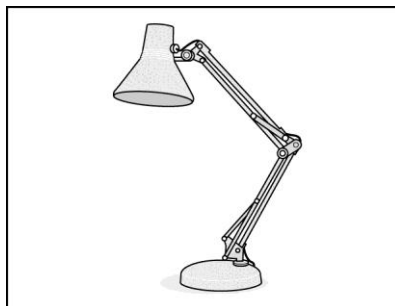

B

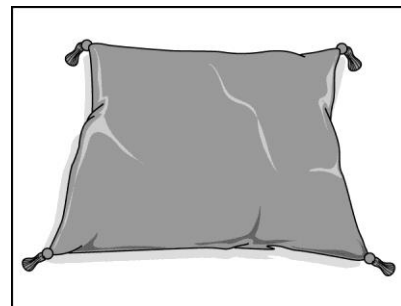

C

2. Why did the plane leave late?

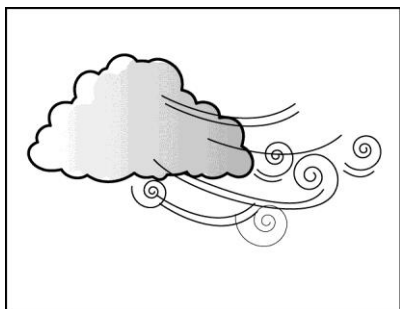

A

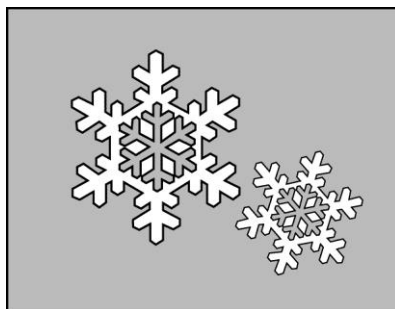

B

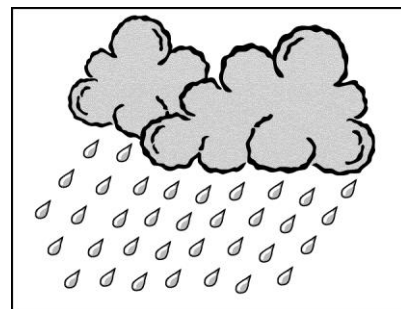

C

3. What activity does the woman want to book for the weekend?



A



B



C

4. Which cake will the girl order?

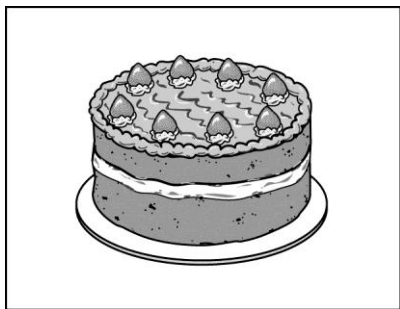

A

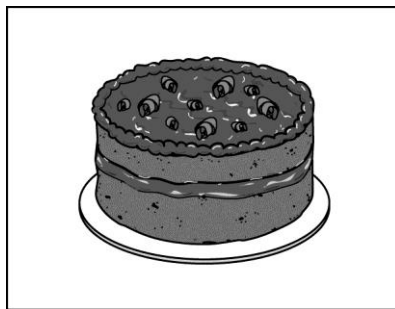

B

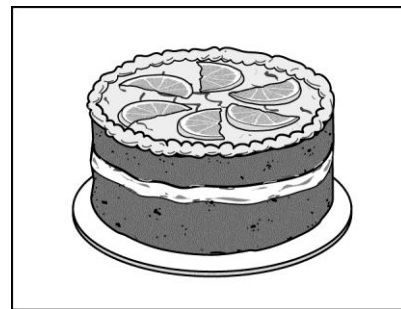

C

5. How much must customers spend to get a free gift?



A



B



C

6. What did the family do on Sunday?



A



B

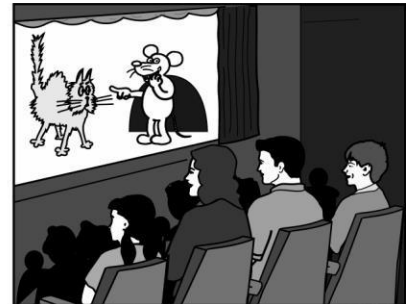

C

7. Which programme is on first?



A



B



C

1	2	3	4	5	6	7

Part 3. Reading

Time: 30 minutes

Task 1

Read the article. Use five of the words from the box to complete the following article about smiling. Choose an appropriate singular or plural form for each word.

a) eyebrow	e) dimple	f) mouth
b) eye	d) cheek	g) tooth
c) wrinkle		

According to research from the USA, we smile for many reasons. There is the listener response smile. When two people are having a conversation, the listener smiles to encourage the speaker. There is the polite smile. This is the sort of smile you make when your aunt gives you a horrible birthday present.

There is the miserable smile. For example, when you go to the dentist, and he tells you that you need to have a 1) _____ taken out.

Very often, these social smiles are not real: they are frequently “fake” smiles. Fake smiles are easy to do – you just have to tighten the muscles in your 2) _____.

But there’s only one smile that is the smile of true enjoyment. This smile is extremely hard to fake. It involves the muscles at the corners of the 3) _____ and the muscles around the eyes.

When someone gives a true smile, the 4) _____ get smaller, and you see little wrinkles around the edge. The eyebrows go up and on some people, 5) _____ appear in their cheeks.

The genuine smile of enjoyment not only makes us feel good, but it makes others feel good too.

1	2	3	4	5

Task 2

Read the article below and match one of the headings (a-d) with each paragraph (6-9).

- a) Shy b) Cheeky c) Confident d) Sociable

6. _____

This is the smile of a joker. The raised eyebrows and dimples in the cheeks show a good sense of humour and a warm personality. This sort of person is often a bit of a rebel – they have no respect for authority.

7. _____

The wide, toothy smile shows that the person is easygoing and friendly. They enjoy being in a crowd and are good fun to go out with. They’re always looking for the next party.

8. _____

The smile is in the eyes. This is a sensitive person, and a loyal friend. This sort of person thinks before they speak and is a good listener. They don’t like being the centre of attention in a crowd.

9. _____

This is a smile that says, “I know it all.” This type of person is very sure of themselves. They like good argument, and they usually win. They’re hard-working and very ambitious. And they can be quite bossy.

6	7	8	9

Task 3**Read the article again. Match these adjectives with their definitions.**

- | | | | |
|--------------|--------------|--------------|-------------|
| a) ambitious | c) confident | e) loyal | g) shy |
| b) bossy | d) easygoing | f) sensitive | h) sociable |

10. certain about his/her abilities
11. continues to support a person in different times
12. really wants to become successful, rich, or famous
13. cares about other people's feelings
14. friendly and enjoy being with other people
15. tells other people what to do all the time
16. relaxed, calm and not easy to upset
17. nervous in the company of other people

10	11	12	13	14	15	16	17

Task 4**Read what six different people are talking about. Choose the most appropriate adjective from Task 3 to describe each one.**

18. "I'd love to meet your friends – let's make a date now. We could try that new restaurant in town."
19. "No, no, don't do it like that. Do it like this. Go on, do it again, and, oh, then get me a cup of tea."
20. "No problem – I'm sure I can win. I know I'm faster than others."
21. "I'm working here to get some experience, but I'm going to start up my own company soon."
22. "Year, whatever – I really don't mind. I'll be happy if we stay in. Let's do whatever you want to do."
23. "Look, are you sure you're OK? Because I can stay longer if you want. Anyway, you know where I am if you need me. Take care."

18	19	20	21	22	23

Task 3

For each question (21-25), write the correct answer. Write one word for each gap.

The Natural History Museum

This is one of my favourite places to visit. I've learned a huge amount about animals and plants
21) _____ time I've visited. I've even seen bits of rock from the moon!

The building's really beautiful and it's easy to find your way around. There are hundreds of interesting things on display, but 22) _____ you like dinosaurs the best time 23) _____ see them is during term-time. I've been twice in the school holidays and the queue was 24) _____ long that I wasn't able to visit that part of the museum.

You'll probably want something to eat while you're there. You can take 25) _____ own picnic and eat in the museum garden, or try one of the two museum cafés.

21	22	23	24	25

Task 4

For questions 26-30, use the correct alternative to complete the idioms.

26. - Is he tired?
- No, he's full of 26) _____.
- Oh, no – he won't want to go to bed.

A	beans	B	spinach	C	mushrooms
---	-------	---	---------	---	-----------

27. - Have you met Pete's sister?
- No, I haven't. Is she like Pete?
- No, not at all. They're like chalk and 27) _____.

A	chicken	B	cheese	C	cherries
---	---------	---	--------	---	----------

28. - Hey, what do you think of the guy over there with a blue shirt on?
- Um – he's OK, but he is not my cup of 28) _____.

A	soup	B	tea	C	hot chocolate
---	------	---	-----	---	---------------

29. - No, I can't. It's too difficult.
- No, it isn't. It's a piece of 29) _____.

A	toast	B	pizza	C	cake
---	-------	---	-------	---	------

30. - What was it like?
- Awful – it was so crowded. We were packed in like 30) _____.
- Oh dear. You won't go there again then, will you?

A	grapes	B	sardines	C	garlic
---	--------	---	----------	---	--------

26	27	28	29	30